

DIVAN D'EXAMEN ÉLECTRIQUE
POWER EXAMINATION COUCH

quest®



DIVANS D'EXAMEN À HAUTEUR VARIABLE

12-2013



quest®

LA RÉFÉRENCE DES DIVANS À HAUTEUR VARIABLE THE REFERENCE FOR POWER COUCHES

CONFORT COMFORT

- Largeur utile 100 % de la sellerie
- Mouvements électriques doux
- Possibilité de combiner pédale et commande manuelle (3 connexions)
- 100 % of the surface usefull
- Smooth electrical motions
- 3 connections possible (possibility to combine hand and foot control)

HYGIÈNE / HYGIENE

- Système Block'n Roll exclusif (modèles 2050-15/30/50)
- Toutes les parties exposées sont accessibles au nettoyage
- Revêtement avec protection antibactérienne (suivant choix de couleur, voir nuancier)
- Exclusive Block'n Roll system (models 2050-10/30/50)
- All exposed parts are cleanable
- Covering with antibacterial protection (depending on the color, see color chart)



Modèle présenté avec options/accessoires
Products shown with options/accessories



SÉCURITÉ SAFETY

- Pied en H très stable
- Capacité 200 kg
- Proclive - Déclive [sur certains modèles]
- Sellerie non-feu M1 (suivant choix de couleur, voir nuancier)
- Bras d'élévation robustes
- Very stable H shaped base
- 200 kg patient weight capacity
- Trendelenburg - reverse trendelenburg (on specific models only)
 - M1 fire retardant upholstery (depending on the color, see color chart)
 - Sturdy elevation arms

ACCESSIBILITÉ ACCESSIBILITY

- Hauteur variable de 54 à 94 cm
- Compatible avec un lève-malade
- Variable height from 54 to 94 cm
- Compatible with a hoist



Accueil
Welcome



Position haute
High position



Examen général
General examination



Déclive
Trendelenburg



Proclive
Reverse trendelenburg

DIVANS D'EXAMEN À HAUTEUR VARIABLE



CARACTÉRISTIQUES STANDARD - modèle 2050-10

Hauteur variable électrique de 54 à 94 cm
Structure acier avec finition époxy gris nuage
Dossier réglable par vérin à gaz ou vérin électrique
Commande manuelle
Patins de réglage sous piètement
Block'n Roll® - Système de roulettes escamotables intégrées semi-centralisé (réf : 2050-15, 2050-30 et 2050-50)
Support rouleau papier (longueur maxi 50 cm - ø 12,5 cm)
12 cm de dégagement au sol compatible avec le passage d'un lève-personne
Connexion de 3 commandes possible
Capacité de charge jusqu'à 200 kg
(testé en dynamique à 250 kg et en statique à 800 kg)

STANDARD FEATURES - model 2050-10

Electric variable height from 54 to 94 cm
Steel frame structure with grey epoxy finish
Gas-spring assisted or electric backrest
Hand control
Adjustable levellers under base
Block'n Roll® - Integrated retractable castor system semi centralized (ref: 2050-15, 2050-30 and 2050-50)
Paper roll holder (max length 50 cm - ø 12,5 cm)
Mobile hoist compatibility clearance of 12 cm
Possibility of 3 control connections
200 kg patient weight capacity
(tested at a dynamic weight of 250 kg and a static weight of 800 kg)

Modèles Models	Patins Levellers	Block'n Roll®	Proctive / Déclive Tredenlenburg Reverse tredenlenburg	Dossier à gaz Gas-spring assisted backrest	Dossier électrique Electric backrest
2050-10	●			●	
2050-15		●		●	
2050-20	●		●	●	
2050-30		●	●	●	
2050-50		●	●		●

Selleries
Upholstery

Tous modèles,
à commander séparément /
All models, to order separately



PLATE
FLAT

Largeur / Width 65 cm..... 600150-65
Largeur / Width 75 cm..... 600150-75



A BOURRELETS
LATERAL PADDINGS

Largeur / Width 65 cm..... 600151-65
Largeur / Width 75 cm..... 600151-75



ANATOMIQUE
FORMED

Largeur / Width 73 cm..... 600150-70

Options*

* A demander impérativement
lors de la commande,
montage usine /
Plant installed, must be
ordered with initial order



600000-01
Montage de sellerie
en usine
Factory assembly fitting
of upholstery



81036
4 roues à frein
double galet ø 50 mm
Set of 4 double castors
with brakes ø 50 mm
(réf./ref: 2050-10, 2050-20)



2230-65 2230-75
Sellerie/upholstery
65 cm Sellerie/upholstery
75 cm
Trou pour visage
Face cutout in head cushion
uniquement sur sellerie plate
only with flat upholstery
600150-65 / 600150-75

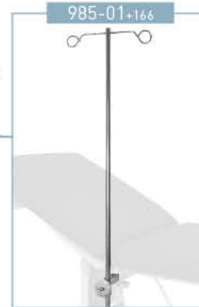

985-01+166

Tige porte-sérum
2 crochets
2 hook IV pole



2985-01+166

Tige porte-sérum
autoverrouillant 2 crochets
Auto-locking 2 hook IV pole

Accessoires
Accessories



166

Paire d'étau
Pair of clamps



840+166

Paire d'appui-jambes
Pair of legrests



850+166

Paire d'étriers
Pair of stirrups



861

Paire de housses
pour appui-jambes
Pair of covers for legrests



2536+166

Appui-bras (unitaire)
Armrest (unit)



2537

Housse pour appui-bras
(unitaire)
Cover for armrest (unit)



2054-01

Appui-tête
compatible avec sellerie
anatomique uniquement
Headrest compatible with
formed upholstery only



2055-01

Rallonge de dossier non
compatible avec sellerie
anatomique
Backrest extension not
compatible with
formed upholstery



1102-10

Appui-tête
Headrest



2051-10

Commande par pédale
Foot control
(réf./ref: 2050-10 + 2050-15)



2051-20

Commande par pédale
Foot control
(réf./ref: 2050-20+2050-30)



2051-30

Commande par pédale
Foot control
(réf./ref: 2050-50)



2056-02

Porte-rouleau réglable
Adjustable paper-roll holder
(350-800 mm)



85114-01

Paire de barrières
Pair of barriers
Non compatible avec les
accessoires / Not compatible
with accessories
166, 985-01, 2985-01











Lightec +166

Se référer à la
documentation
Refer to the literature

**Choix de selleries non-feu M1
Antibactérien**
Choice of M1 fire retardant
and antibacterial upholstery

Classic

-  32 - BLEU / BLUE
-  93 - COTTAGE / COTTAGE
-  35 - ROUGE / RED
-  34 - JAUNE / YELLOW
-  91 - BLANC / WHITE
-  92 - MARINE / MARINE
-  56 - OBSCURE / DARKNESS
-  57 - ANTISTATIQUE / ANTISTATIC
Non classé M1 / Not classified M1



Vitamin

-  64 - RAISIN / GRAPE
-  67 - LAGON / LAGOON
-  66 - BONBON / SWEET
-  63 - CEDRAT / CEDRAT

Cosy

-  80 - CIEL / SKY
-  81 - VERT D'EAU / SEA GREEN
-  65 - LILAS / LILAC
-  96 - ETAIN / TIN
-  82 - GRIS SOURIS / MOUSE GREY
-  83 - NATUREL / NATURAL
-  84 - CHOCOLAT / CHOCOLATE

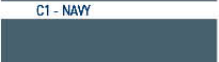
Selleries RITTER
RITTER upholstery
Non classé M1
Not classified M1

-  C1 - NAVY
-  C2 - DUSTY BLUE
-  C3 - MOSS

ANTIBACTÉRIEN / NON FEU M1 - ANTIBACTERIAL / M1 FIRE RETARDANT



Poids net
Net weight
Divan / Couch 83 kg
Sellerie / Upholstery 21 kg

Poids brut
Gross weight
Divan / Couch 121 kg
Sellerie / Upholstery 25 kg

Volume
Divan / Couch 0,96 m³
Sellerie / Upholstery 0,28 m³

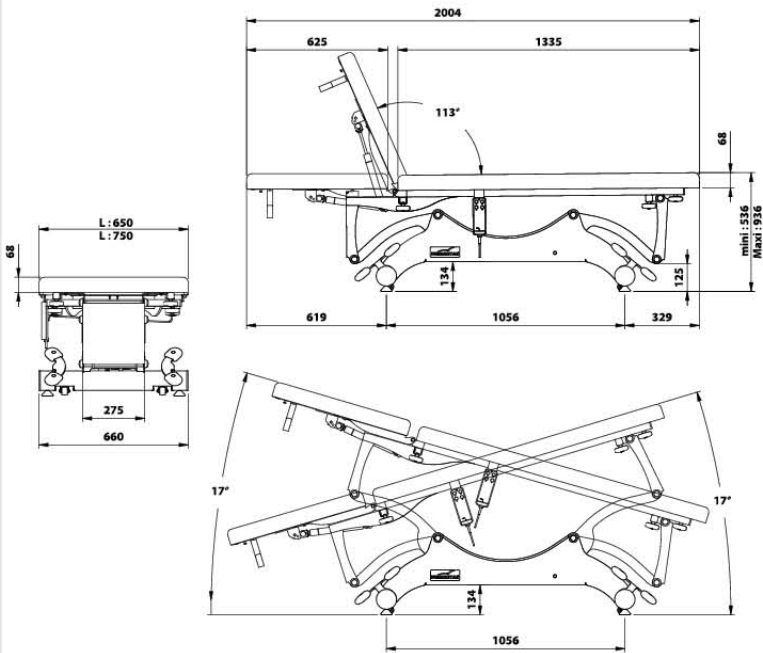

DIVANS D'EXAMEN À HAUTEUR VARIABLE

